

IF THIS SHEET IS NOT 30\"/>

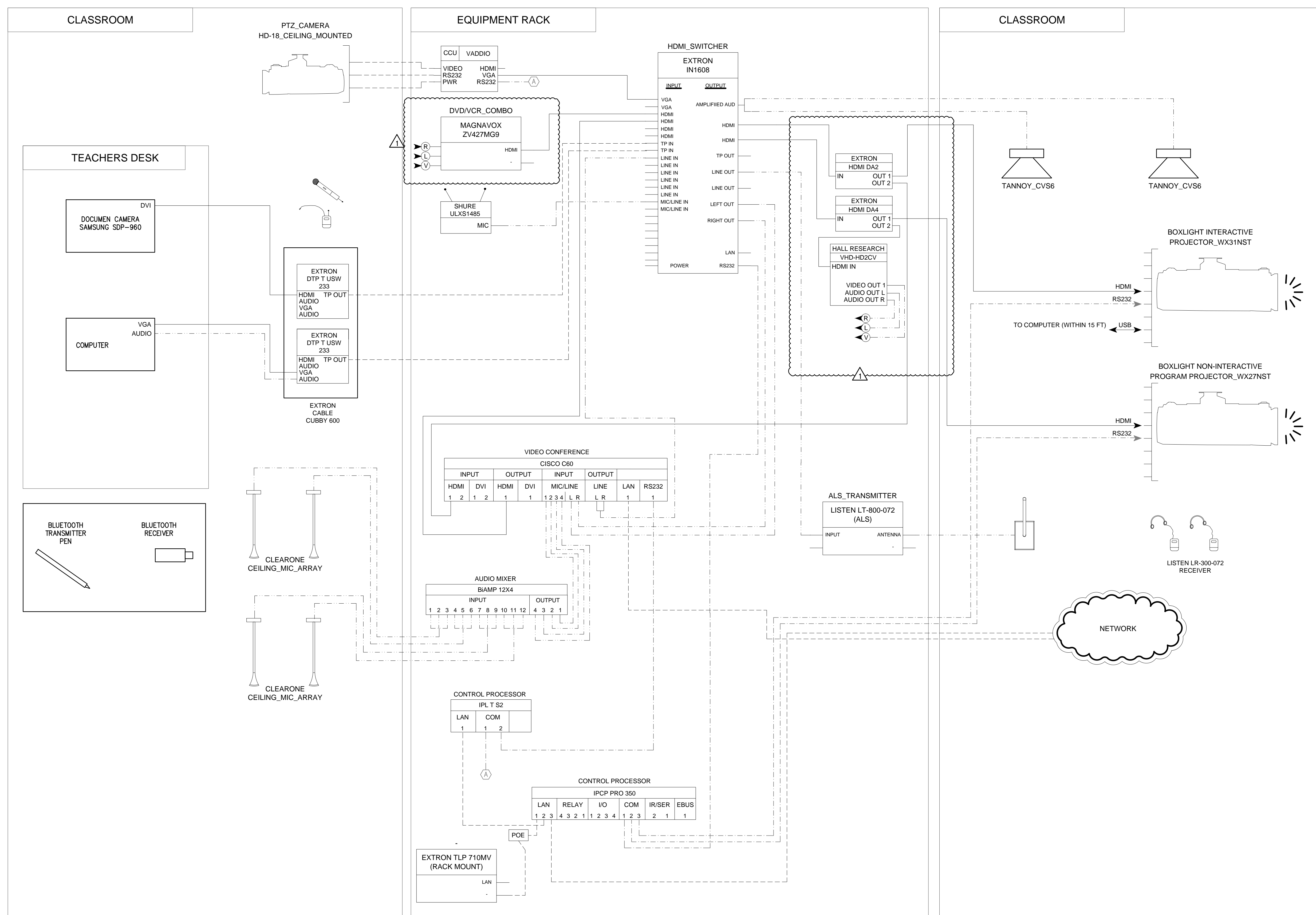

**PERALTA COMMUNITY COLLEGE DISTRICT**  
333 EAST EIGHTH STREET,  
OAKLAND, CALIFORNIA 94606

Revisions				
No.	Revisions	By	Date	Appr.
	50% CONSTRUCTION DOCUMENTS		02-25-14	
	75% CONSTRUCTION DOCUMENTS		03-03-14	
	99% CONSTRUCTION DOCUMENTS		07-14-14	
	BID DOCUMENTS		10-10-14	
	ADDENDUM 2	TLK	01-13-15	



**NOTES:**  
1. THIS IS A CONCEPTUAL BASED DRAWING AND IS NOT INTENDED FOR WIRING DIAGRAM USE.

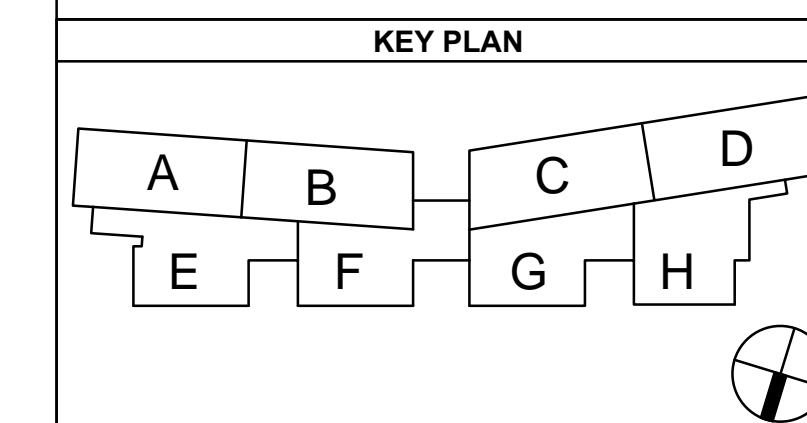

**BID DOCUMENTS**

**WHM INCORPORATED**  
Engineering Consultants  
1605 School Street  
Moraga, CA 94556  
Tel (925)376-2902 \* Fax (925)376-2904  
cod@whminc.com  
13-075

This document is the property of the Owner and is not to be used without his written permission.  
Architect/Engineer Of Record:

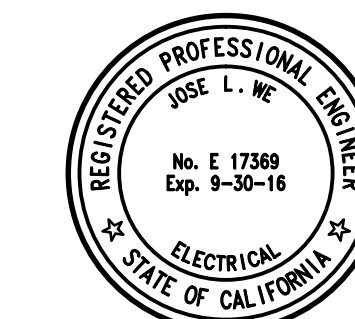

**HY HIBSER YAMAUCHI Architects, Inc.**  
300 27th Street  
Oakland, CA 94612  
510.446.2222 tel | 510.446.2222 fax

HY Architects Project number: 3897.00

Facility  
PERALTA COMMUNITY COLLEGE DISTRICT  
12500 CAMPUS DRIVE,  
OAKLAND CA, 94619

Project  
**MERRITT COLLEGE - CENTER FOR SCIENCE AND ALLIED HEALTH - AV**

Sheet Title  
**AUDIO/VISUAL RISER DIAGRAM - LEVEL 2**

Client Project Number: AS NOTED Client Proj. #  
Scale: AS NOTED  
Drawn By: DM  
Checked By: TK  
Issue Date: 10-10-14  
Sheet **AD2-AV.02B** of Sheets

1

**RISER DIAGRAM - LEVEL 2**

SCALE NONE

01/12/15 11:04:14 AM F:\2013\13-075 MERRITT COLLEGE\_A\13075AVS.02B.DWG



IF THIS SHEET IS NOT 30\"/>

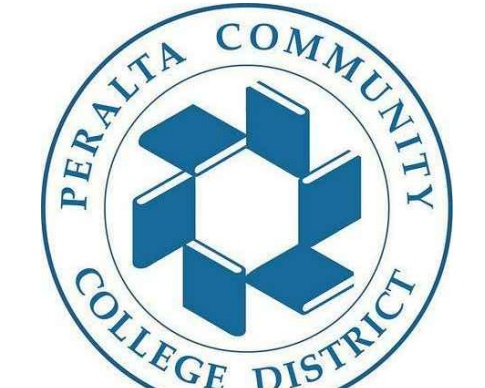

**PERALTA COMMUNITY COLLEGE DISTRICT**  
 333 EAST EIGHTH STREET,  
 OAKLAND, CALIFORNIA 94606

Revisions				
No.	Revisions	By	Date	Appr.
50%	CONSTRUCTION DOCUMENTS		02-25-14	
75%	CONSTRUCTION DOCUMENTS		03-03-14	
99%	CONSTRUCTION DOCUMENTS		07-14-14	
	BID DOCUMENTS		10-10-14	
Δ	APPENDUM 2	TLK	01-13-15	

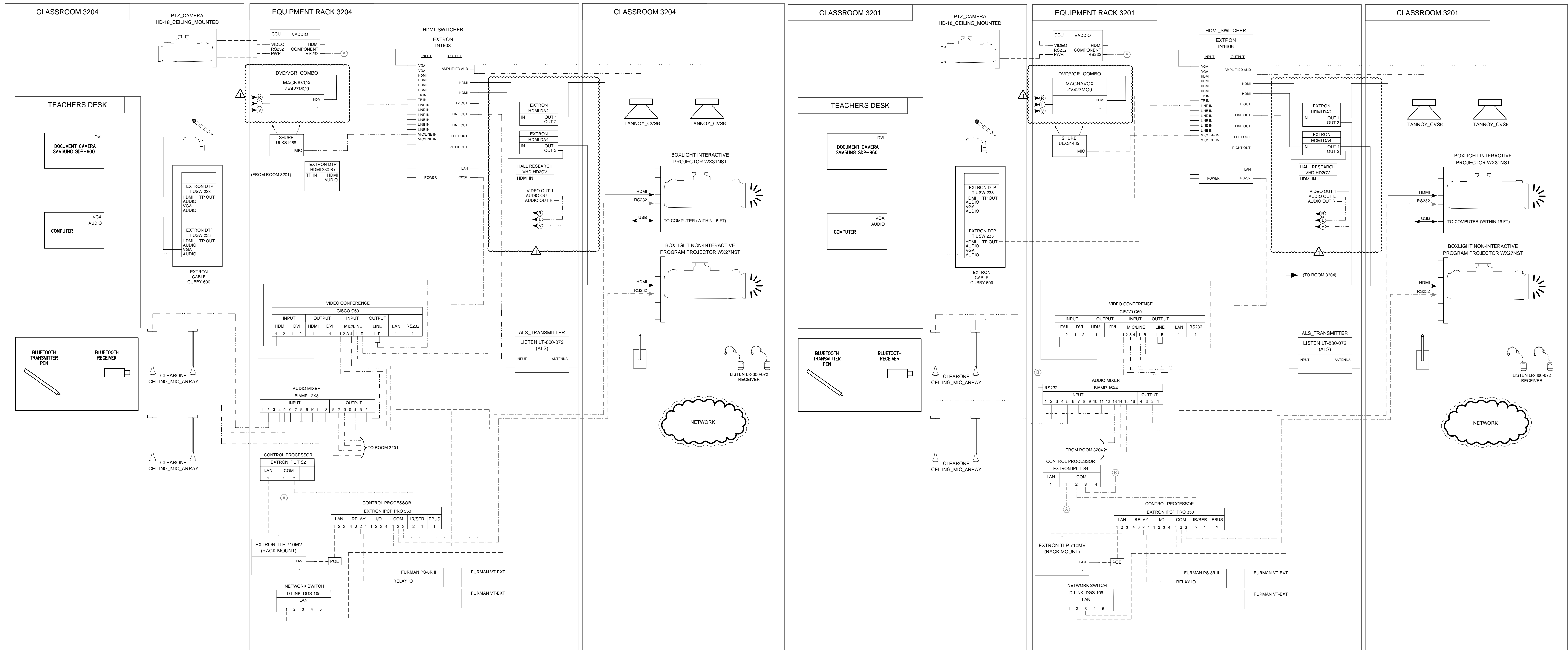

**NOTES:**  
 1. THIS IS A CONCEPTUAL BASED DRAWING AND IS NOT INTENDED FOR WIRING DIAGRAM USE.

**1 RISER DIAGRAM - LEVEL 3 (2 LEVEL 2 WITH INTERCONNECTION)**

SCALE NONE

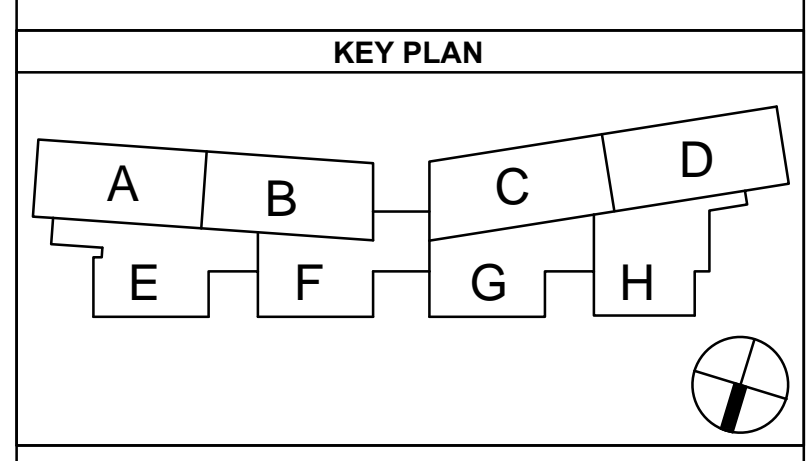

**BID DOCUMENTS**

**WHM INCORPORATED**  
 Engineering Consultants  
 1605 School Street  
 Moraga, CA 94556  
 Tel (925)376-2902 \* Fax (925)376-2904  
 cod@whmnc.com  
 13-075

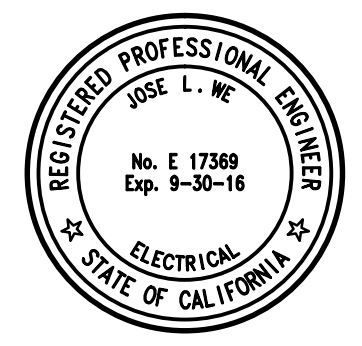

**HY HIBSER YAMAUCHI Architects, Inc.**  
 300 27th Street  
 Oakland, CA 94612  
 510.446.2222 | 510.446.2222 fax  
 HY Architects Project number: 3897.00

Facility  
**PERALTA COMMUNITY COLLEGE DISTRICT**  
 12500 CAMPUS DRIVE,  
 OAKLAND CA, 94619

Project  
**MERRITT COLLEGE - CENTER FOR SCIENCE AND ALLIED HEALTH - AV**

Sheet Title  
**AUDIO/VISUAL RISER DIAGRAM - LEVEL 2 WITH INTERCONNECTION**

Client Project Number:	Client Proj. #
Scale: AS NOTED	Sheet
Drawn By: DM	<b>AD2-AV.03B</b>
Checked By: TK	of Sheets
Issue Date: 10-10-14	

01/12/15 11:03:41 AM F:\2013\13-075 MERRITT COLLEGE\_AV\13075AVS.03B.DWG



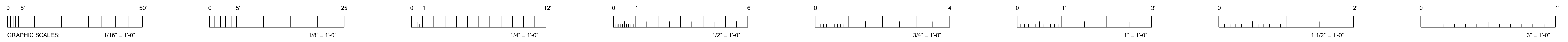

IF THIS SHEET IS NOT 30\"/>

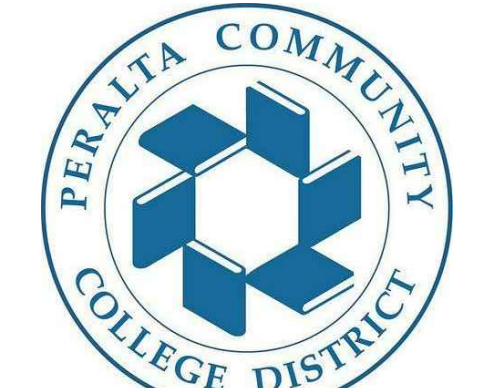

**PERALTA COMMUNITY COLLEGE DISTRICT**  
333 EAST EIGHTH STREET,  
OAKLAND, CALIFORNIA 94606

No.	Revisions	By	Date	Appr.
50%	CONSTRUCTION DOCUMENTS		02-25-14	
75%	CONSTRUCTION DOCUMENTS		03-03-14	
98%	CONSTRUCTION DOCUMENTS		07-14-14	
	BID DOCUMENTS		10-10-14	
	ADDENDUM 2	TLK	01-13-15	

**KEY PLAN**

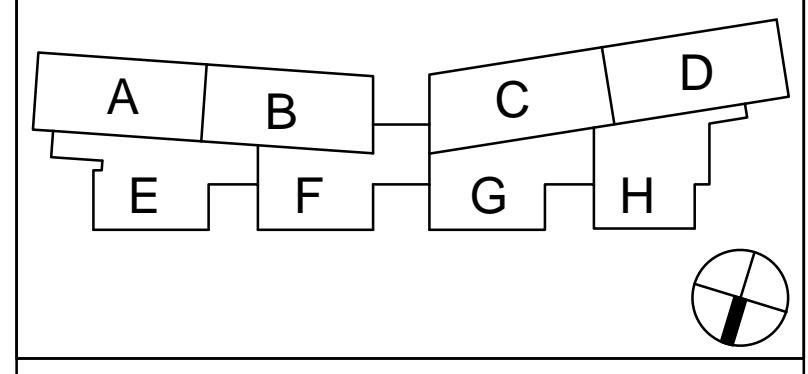

**BID DOCUMENTS**

**WHM INCORPORATED**  
Engineering Consultants  
1605 School Street  
Moraga, CA 94556  
Tel (925)376-2902 \* Fax (925)376-2904  
cod@whminc.com  
13-075

This document is the property of the Owner and is not to be used without his written permission.  
Architect/Engineer Of Record.

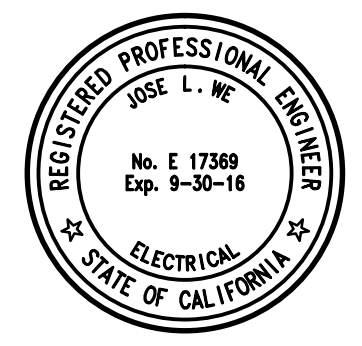

**HIBSER YAMAUCHI Architects, Inc.**

300 27th Street  
Oakland, CA 94612  
510.446.2222 ext | 510.446.2222 fax  
HY Architects Project number: 3897.00

Facility  
**PERALTA COMMUNITY COLLEGE DISTRICT**  
12500 CAMPUS DRIVE,  
OAKLAND CA, 94619

Project  
**MERRITT COLLEGE - CENTER FOR SCIENCE AND ALLIED HEALTH - AV**

Sheet Title  
**AUDIO/VISUAL RISER DIAGRAM - LEVEL 6**

Client Project Number: Client Proj. #

Scale: AS NOTED  
Drawn By: DM  
Checked By: TK  
Issue Date: 10-10-14

Sheet  
**AD2-AV5.04B**  
of Sheets

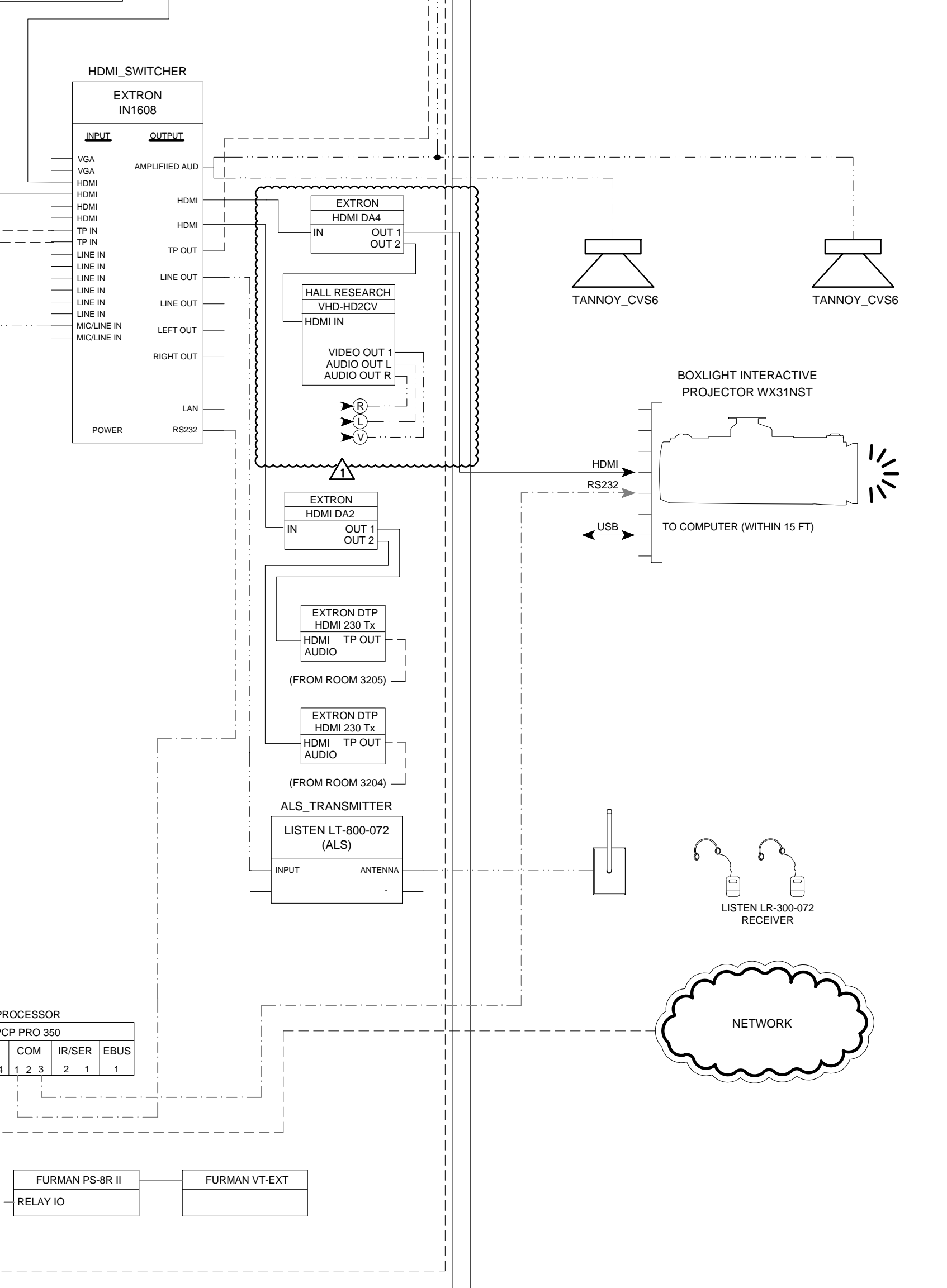
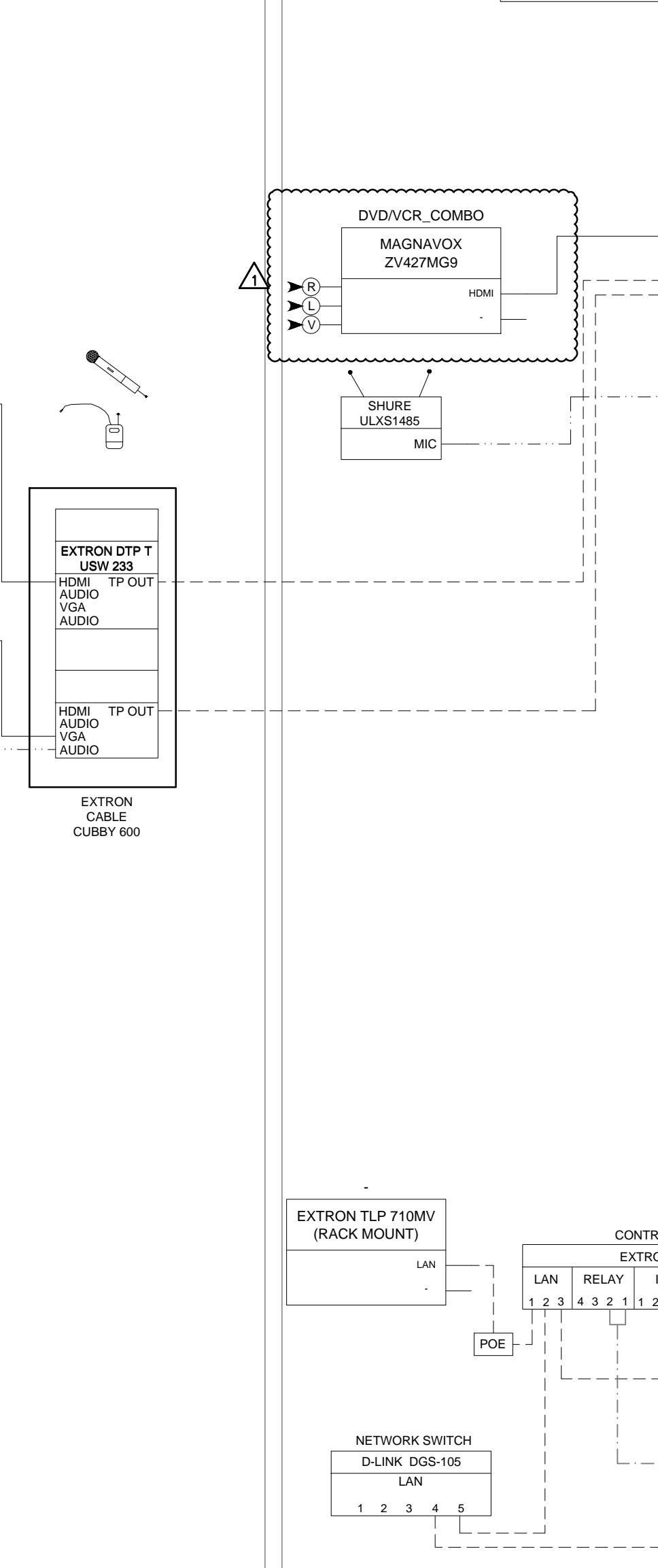
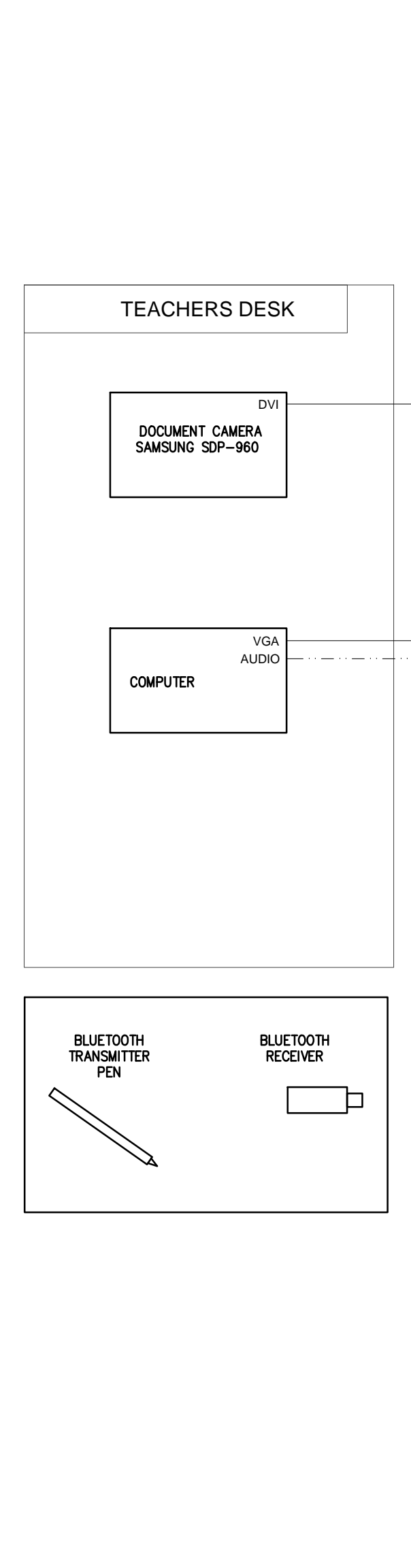
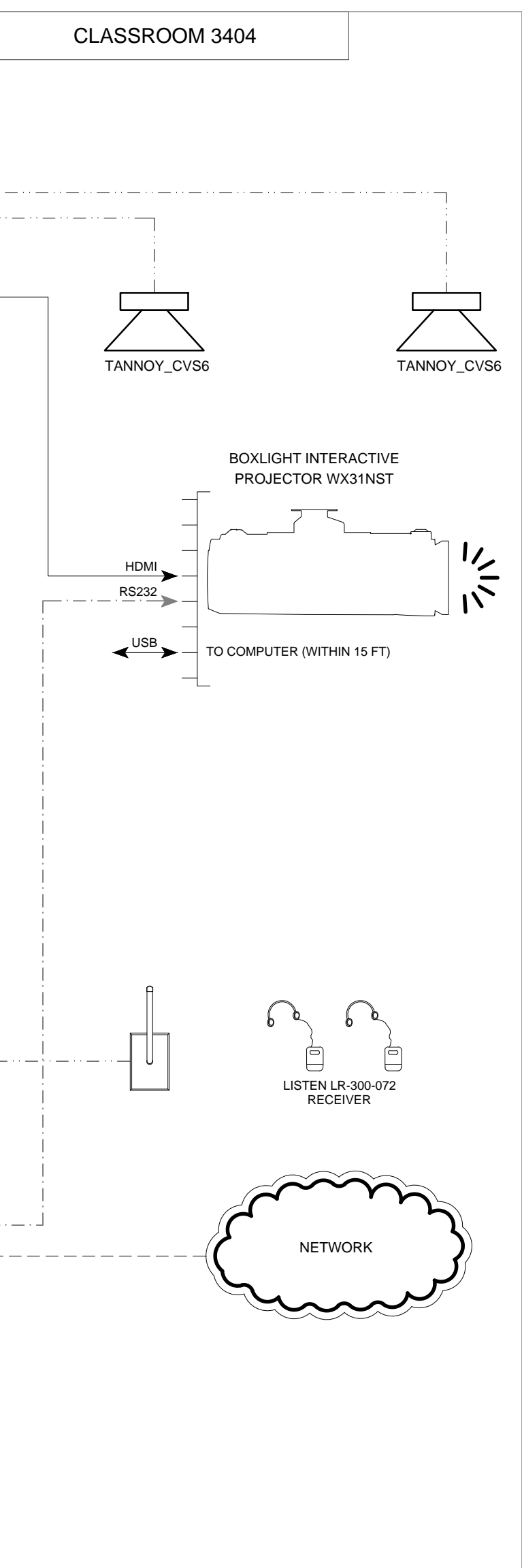
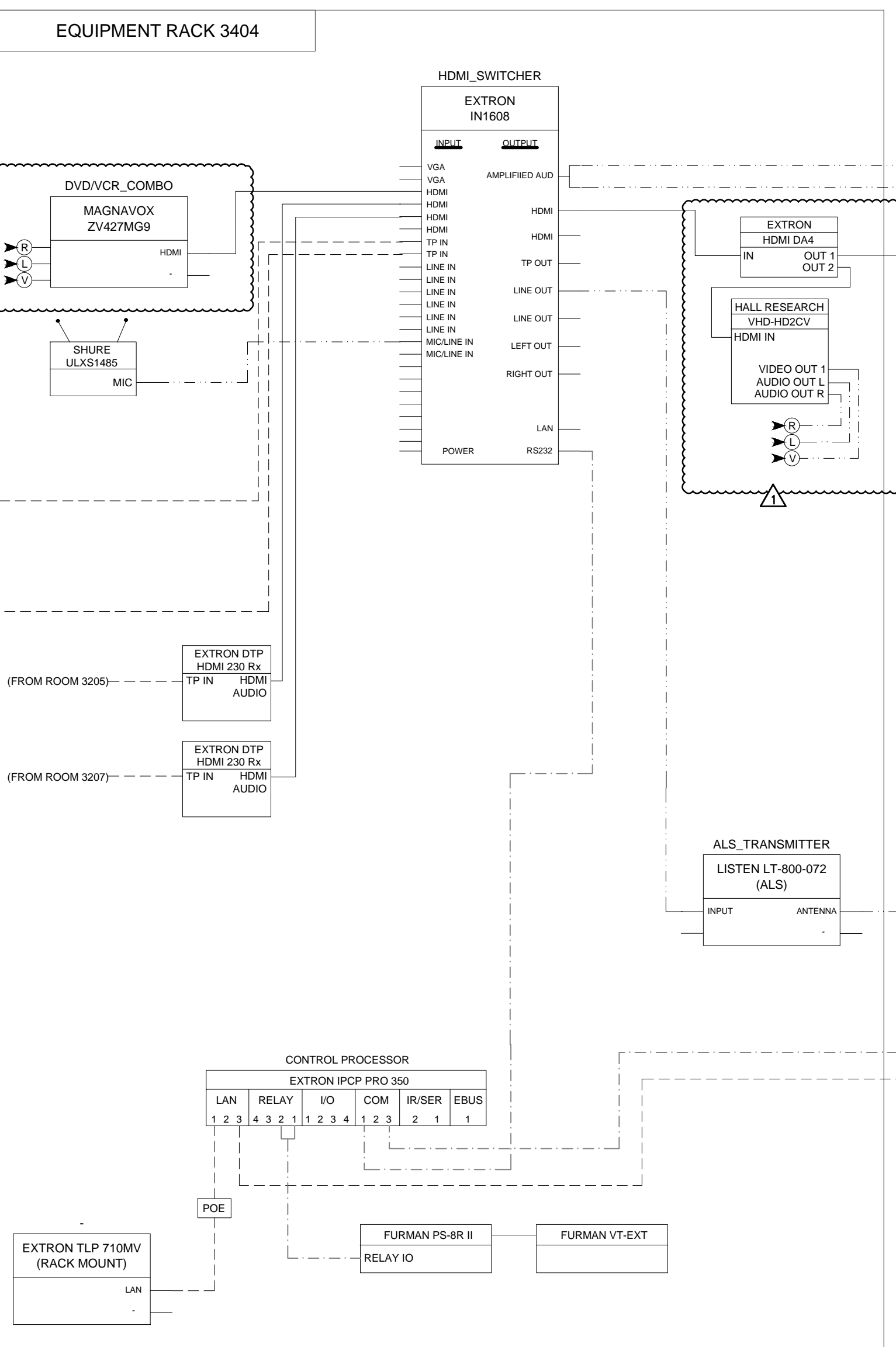
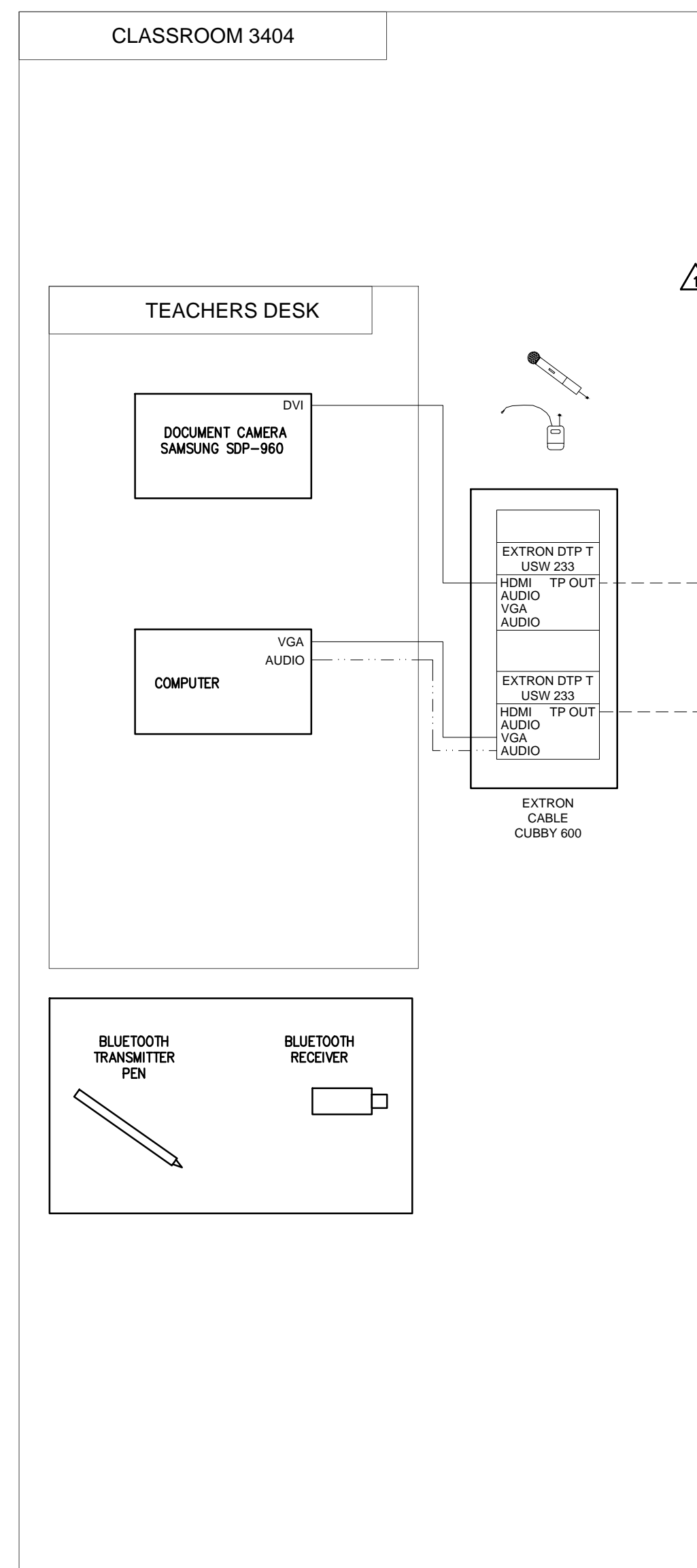
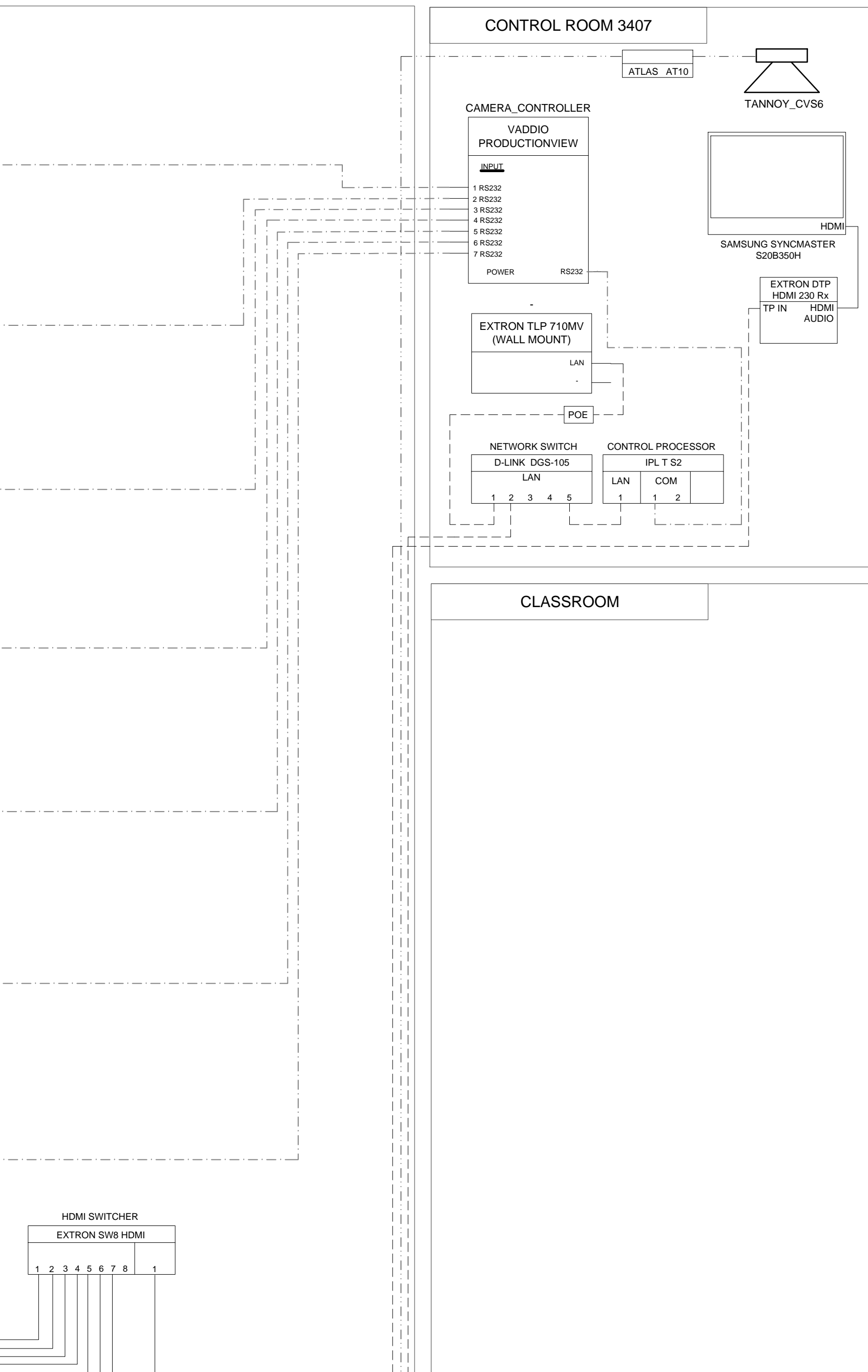
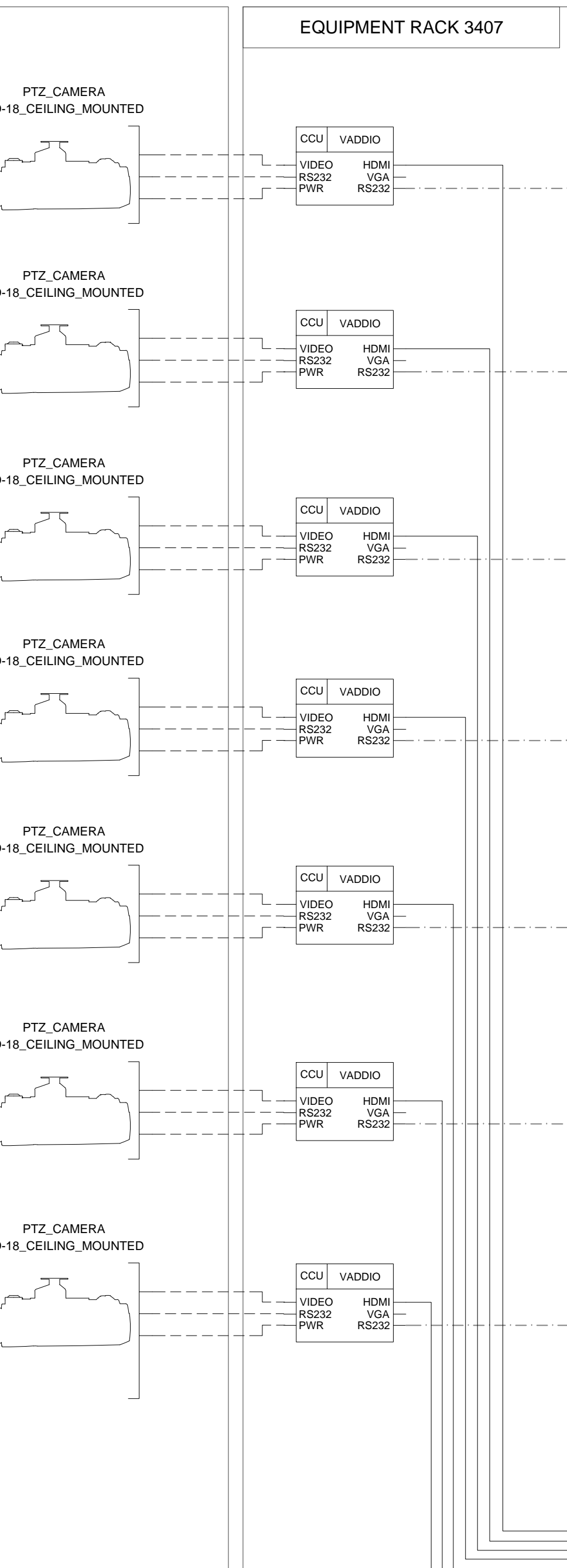
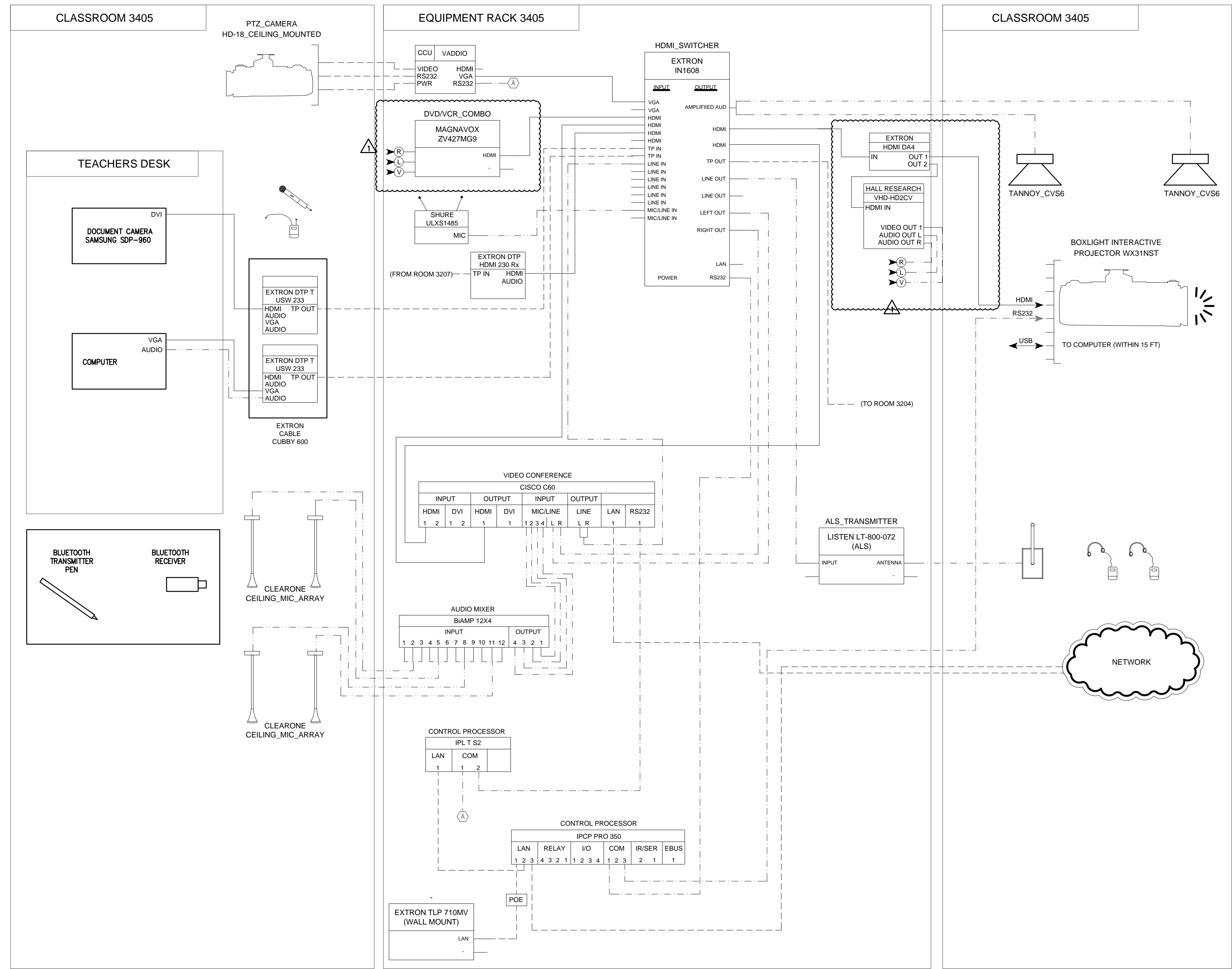

**NOTES:**  
1. THIS IS A CONCEPTUAL BASED DRAWING AND IS NOT INTENDED FOR WIRING DIAGRAM USE.  
2. -

**RISER DIAGRAM - LEVEL 6**  
SCALE NONE

1

01/12/15 11:03:52 AM F:\2013\13-075 MERRITT COLLEGE - AV\13075AV5.04B.DWG



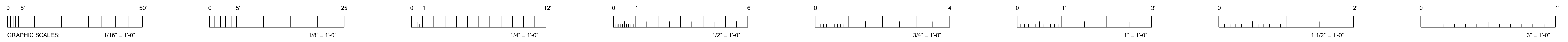

IF THIS SHEET IS NOT 30\"/>

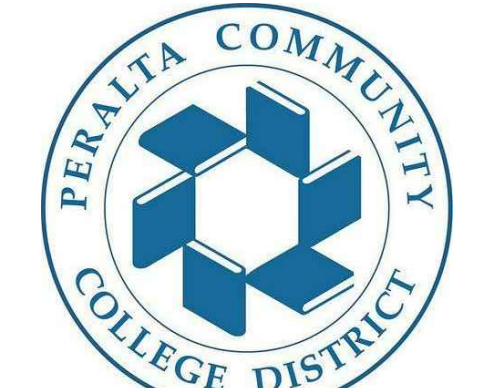

**PERALTA COMMUNITY COLLEGE DISTRICT**  
333 EAST EIGHTH STREET,  
OAKLAND, CALIFORNIA 94606

Revisions				
No.	Revisions	By	Date	Appr.
50%	CONSTRUCTION DOCUMENTS		02-25-14	
75%	CONSTRUCTION DOCUMENTS		03-03-14	
98%	CONSTRUCTION DOCUMENTS		07-14-14	
	BID DOCUMENTS		10-10-14	
Δ	ADDENDUM 2	TLK	01-13-15	

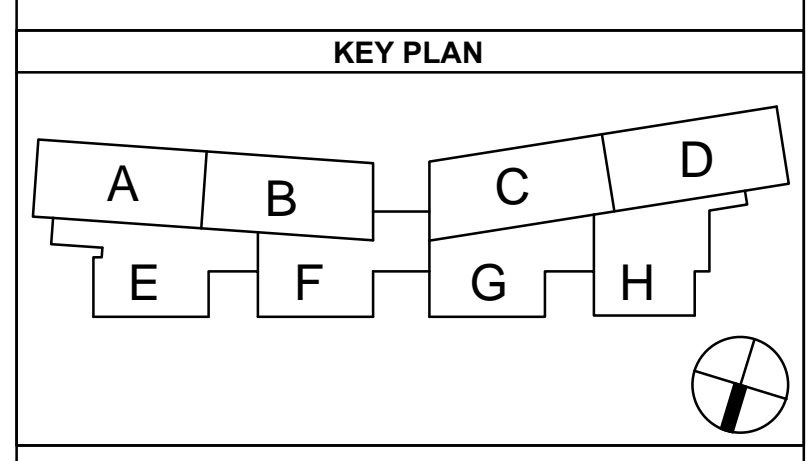
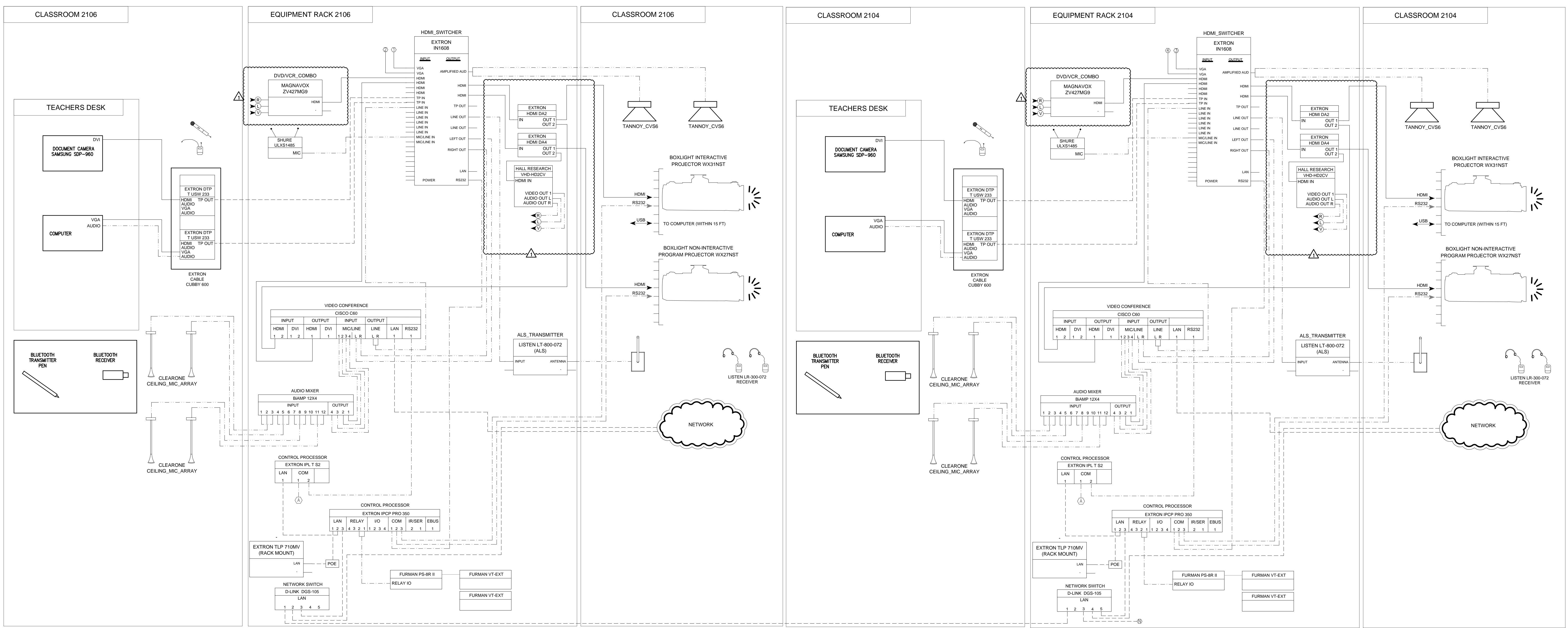
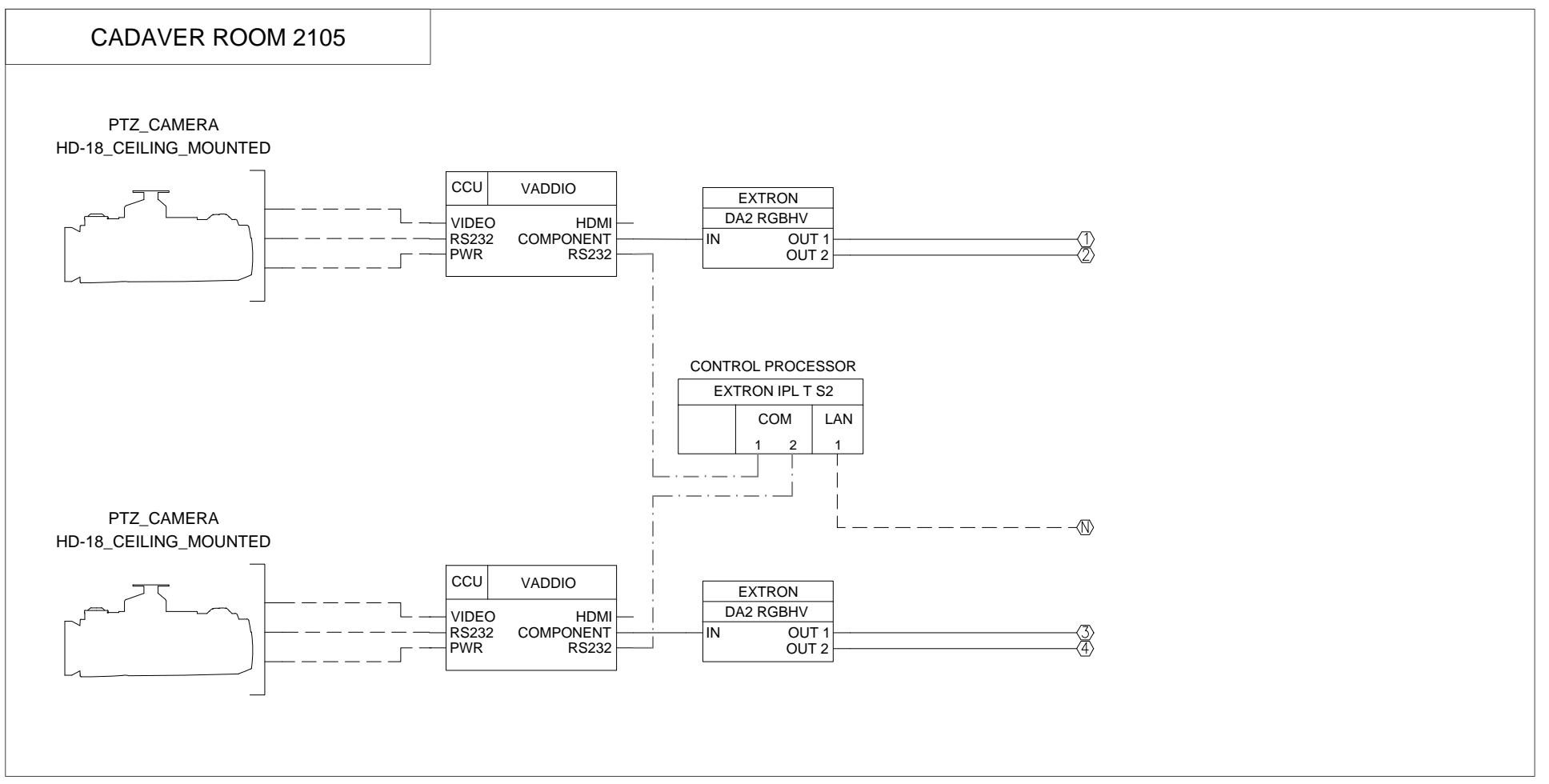

**BID DOCUMENTS**

**WHM INCORPORATED**  
Engineering Consultants  
1605 School Street  
Moraga, CA 94556  
Tel (925)376-2902 \* Fax (925)376-2904  
cod@whmnc.com  
13-075

This document is the property of the Owner and is not to be used without his written permission.  
Architect/Engineer Of Record.

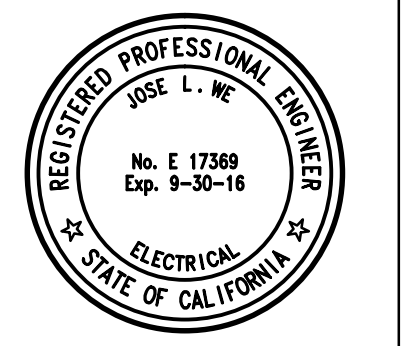

**HY HIBSER YAMAUCHI Architects, Inc.**  
300 27th Street  
Oakland, CA 94612  
510.446.2222 ext | 510.446.2222 fax  
HY Architects Project number: 3897.00

Facility  
**PERALTA COMMUNITY COLLEGE DISTRICT**  
12500 CAMPUS DRIVE,  
OAKLAND CA, 94619

Project  
**MERRITT COLLEGE - CENTER FOR SCIENCE AND ALLIED HEALTH - AV**

Sheet Title  
**AUDIO/VISUAL RISER DIAGRAM - LEVEL 4**

Client Project Number:	Client Proj. #
Scale: AS NOTED	Sheet
Drawn By: DM	<b>AD2-AV.05B</b>
Checked By: TK	of Sheets
Issue Date: 10-10-14	

**NOTES:**  
1. THIS IS A CONCEPTUAL BASED DRAWING AND IS NOT INTENDED FOR WIRING DIAGRAM USE.

**1 RISER DIAGRAM – LEVEL 4**  
SCALE NONE

01/12/15 11:04:01 AM F:\2013\13-075 MERRITT COLLEGE\_A\13075AVS.OSB.DWG

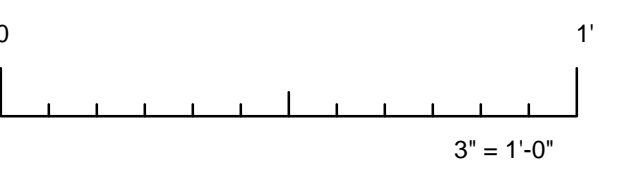
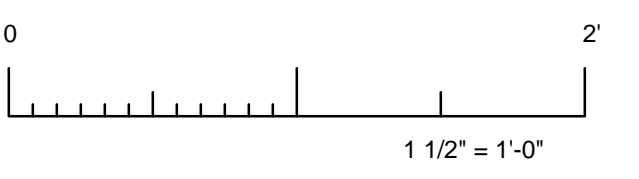
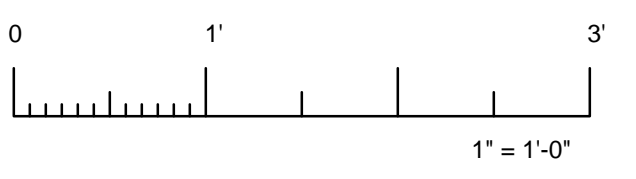
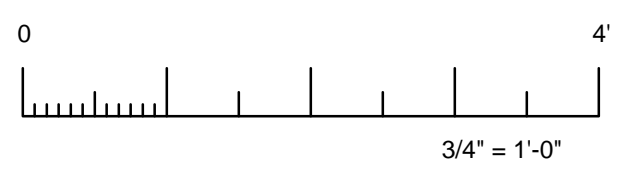
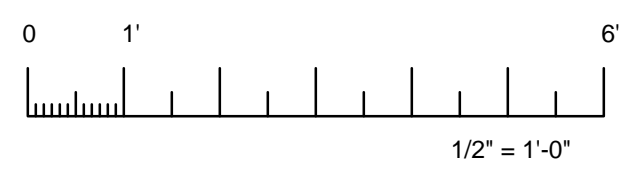
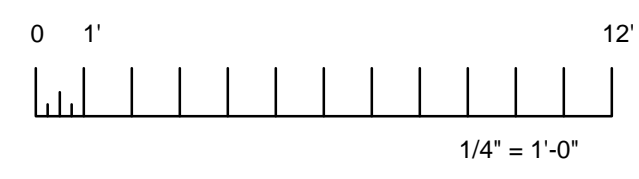
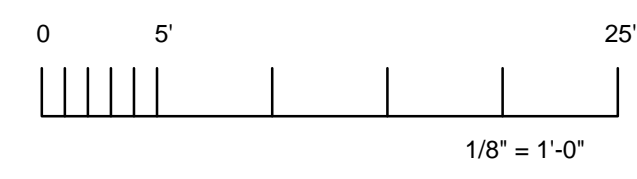
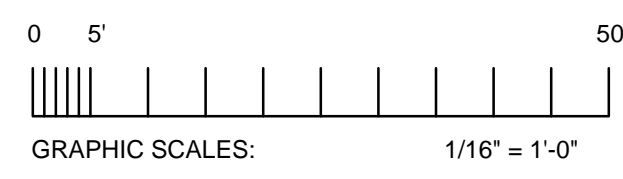

IF THIS SHEET IS NOT 30\"/>

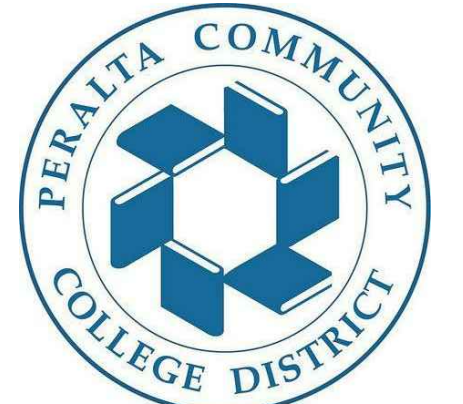

**PERALTA COMMUNITY COLLEGE DISTRICT**  
333 EAST EIGHTH STREET,  
OAKLAND, CALIFORNIA 94606

Revisions				
No.	Revisions	By	Date	Appr.
50%	CONSTRUCTION DOCUMENTS		02-25-14	
75%	CONSTRUCTION DOCUMENTS		03-03-14	
99%	CONSTRUCTION DOCUMENTS		07-14-14	
	BID DOCUMENTS		10-10-14	
▲	ADDENDUM 2	TLK	01-13-15	

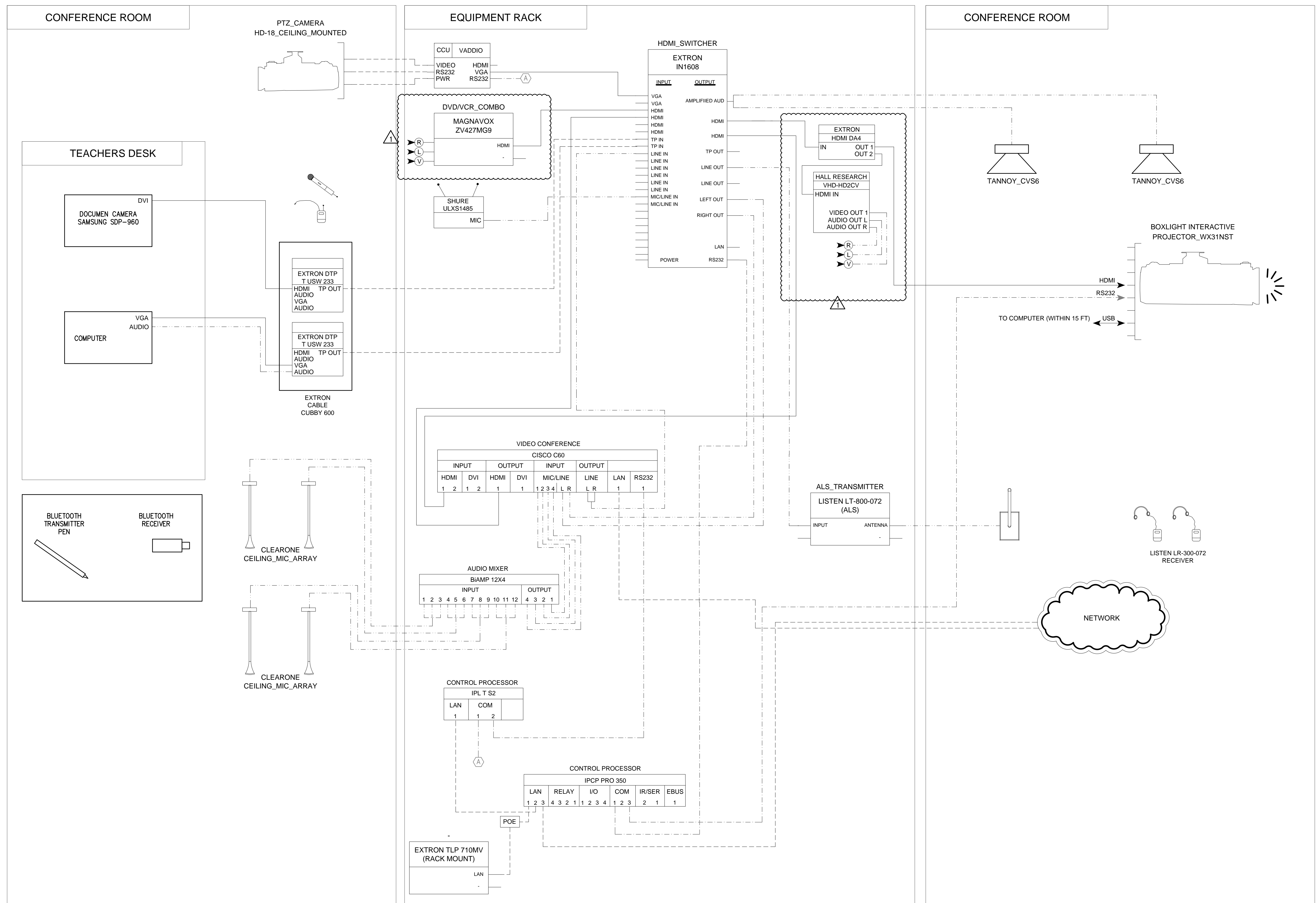

**NOTES:**  
1. THIS IS A CONCEPTUAL BASED DRAWING AND IS NOT INTENDED FOR WIRING DIAGRAM USE.

# 1 RISER DIAGRAM – LEVEL 5

SCALE NONE

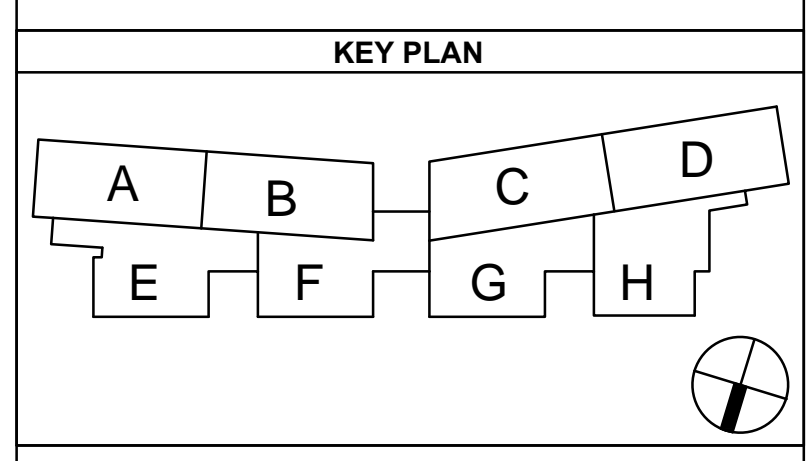

## BID DOCUMENTS

**WHM INCORPORATED**  
Engineering Consultants  
1605 School Street  
Moraga, CA 94556  
Tel (925)376-2902 \* Fax (925)376-2904  
cod@whmnc.com  
13-075

This document is the property of the Owner and is not to be used without his written permission.  
Architect/Engineer Of Record:

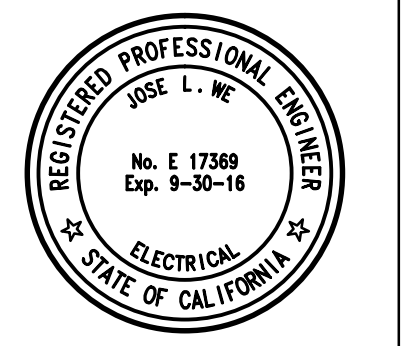

**HY HIBSER YAMAUCHI Architects, Inc.**  
300 27th Street  
Oakland, CA 94612  
510.446.2222 tel | 510.446.2222 fax  
HY Architects Project number: 3897.00

Facility  
**PERALTA COMMUNITY COLLEGE DISTRICT**  
12500 CAMPUS DRIVE,  
OAKLAND CA, 94619  
Project  
**MERRITT COLLEGE - CENTER FOR SCIENCE AND ALLIED HEALTH - AV**

Sheet Title  
**AUDIO/VISUAL RISER DIAGRAM - LEVEL 5**

Client Project Number: Client Proj. #  
Scale: AS NOTED Sheet  
Drawn By: DM **AD2-AV5.06B**  
Checked By: TK  
Issue Date: 10-10-14 of Sheets

01/12/15 11:04:10 AM F:\2013\13-075 MERRITT COLLEGE\_A\13075AV5.06B.DWG